

## DESCRIPTION:

Thanks to highly sensitive triggering levels, the BT168 SCR series is suitable for all applications where the available gate current is limited, such as ground fault circuit interruptors, overvoltage crowbar protection in low power supplies, capacitive ignition circuits, ...

## MAIN FEATURES

Symbol	Value	Unit
$I_{T(RMS)}$	1.5	A
$V_{DRM}$ $V_{RRM}$	>850	V
$I_{GT}$	200	$\mu$ A

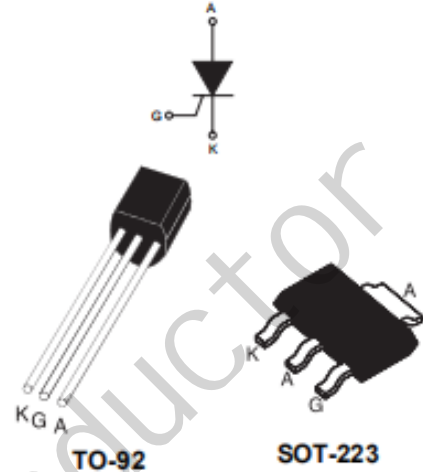

## ABSOLUTE MAXIMUM RATINGS

Parameter	Symbol	Value	Unit
Storage junction temperature range	$T_{stg}$	-40 ~ 150	$^{\circ}$ C
Operating junction temperature range	$T_j$	-40~125	$^{\circ}$ C
Repetitive peak off-state voltage ( $T = 25^{\circ}$ C)	$V_{DRM}$	>850	V
Repetitive peak reverse voltage ( $T = 25^{\circ}$ C)	$V_{RRM}$	>850	V
Non repetitive surge peak Off-state voltage	$V_{DSM}$	$V_{DRM} + 100$	V
Non repetitive peak reverse voltage	$V_{RSM}$	$V_{RRM} + 100$	V
RMS on-state current	$I_{T(RMS)}$	1.0	A
Non repetitive surge peak on-state current (180 $^{\circ}$ conduction angle, $F=50$ Hz)	$I_{TSM}$	15	A
Average on-state current (180 $^{\circ}$ conduction angle)	$I_{T(AV)}$	0.6	A
$I^2t$ value for fusing ( $t_p=10$ ms)	$I^2t$	0.72	$A^2S$
Critical rate of rise of on-state current ( $I = 2 \times I_{GT}$ , $t_r \leq 100$ ns)	$dI/dt$	50	$A/\mu S$
Peak gate current	$I_{GM}$	1.0	A
Average gate power dissipation	$P_{G(AV)}$	0.1	W

**ELECTRICAL CHARACTERISTICS (T=25°C unless otherwise specified)**

Symbol	Test Condition		Value	Unit
$I_{GT}$	$V = 12V$ $R = 140\Omega$	MAX.	200	$\mu A$
$V_{GT}$		MAX.	1.0	V
$V_{GD}$	$V_D = V_{DRM}$ $T_j = 125^\circ C$ $R = 1K\Omega$	MIN.	0.2	V
$I_L$	$I_G = 1.2I_{GT}$	MAX.	6	mA
$I_H$	$I_T = 50mA$	MAX.	5	mA
dV/dt	$V_D = 2/3V_{DRM}$ Gate Open $T_j = 125^\circ C$	MIN.	25	V/ $\mu s$

**STATIC CHARACTERISTICS**

Symbol	Parameter		Value(MAX.)	Unit
$V_{TM}$	$I_{TM} = 2.0A$ $t_p = 380\mu s$	$T_j = 25^\circ C$	1.75	V
$I_{DRM}$	$V_D = V_{DRM}$ $V_R = V_{RRM}$	$T_j = 25^\circ C$	5	$\mu A$
$I_{RRM}$		$T_j = 125^\circ C$	0.5	mA

**Thermal Resistances**

Symbol	Parameter		Value(MAX.)	Unit
$R_{th(j-a)}$	junction to ambient	TO-92	150	$^\circ C/W$
		SOT-223	60	
$R_{th(j-l)}$	Junction to lead (DC) TO-92		60	
$R_{th(j-t)}$	Junction to tab (DC) SOT-223		30	

FIG.1 Maximum power dissipation versus Average on-state current

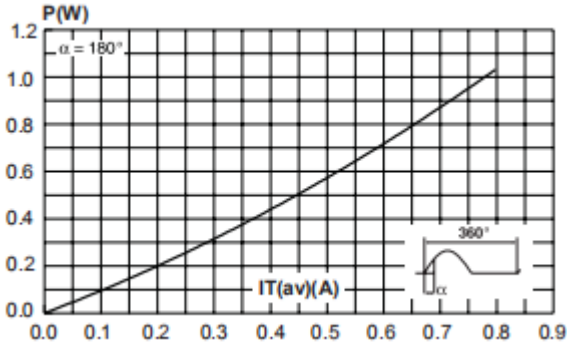

FIG.2: Average on-state current versus case temperature

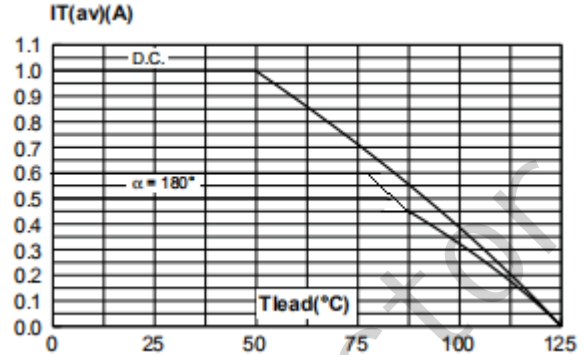

FIG.3: Surge peak on-state current versus number of cycles

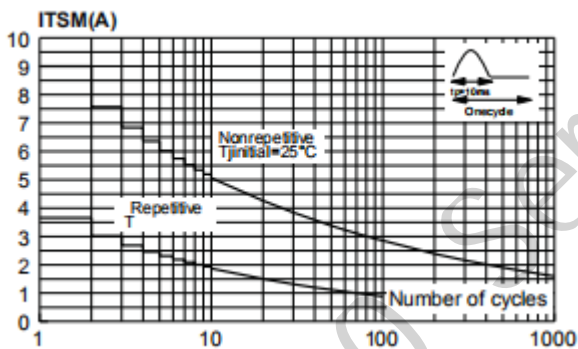

FIG.4: On-state characteristics (maximum values)

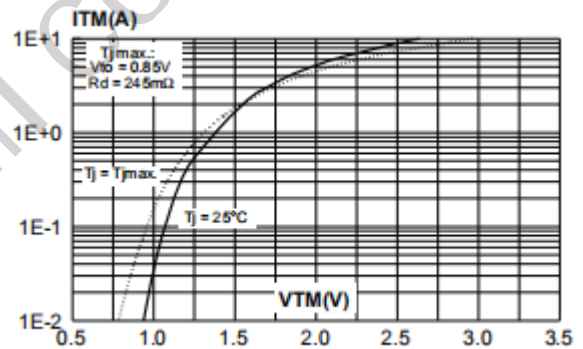

FIG.5: Non-repetitive surge peak on-state current for a sinusoidal pulse with width  $t_p < 10\text{ms}$ , and corresponding value of  $I^2 t$  ( $di/dt < 50\text{A}/\mu\text{s}$ )

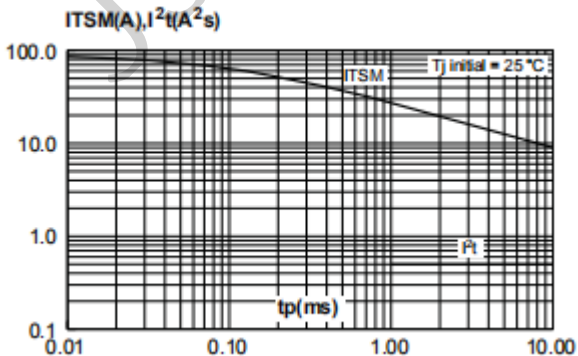
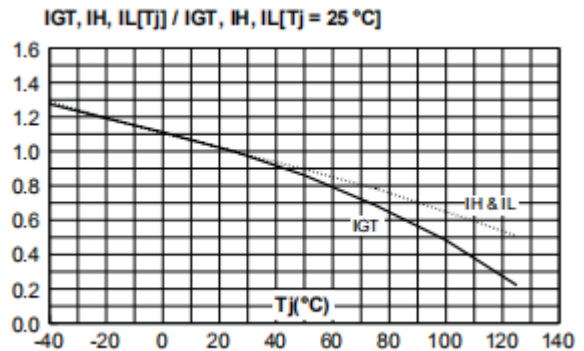
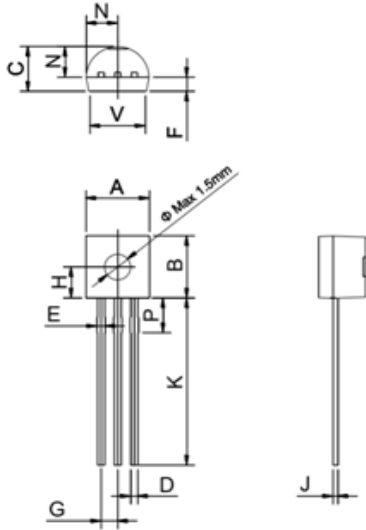
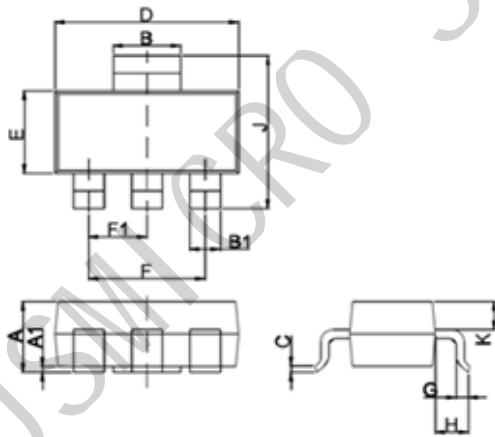

FIG.6: Relative variations of gate trigger current holding current and latching current versus junction temperature



**TO-92 Package Mechanical Data**

Ref.	Dimensions					
	Millimeters			Inches		
	Min.	Typ.	Max.	Min.	Typ.	Max.
A	4.45		5.20	0.175		0.205
B	4.32		5.33	0.170		0.210
C	3.18		4.19	0.125		0.165
D	0.407		0.533	0.016		0.021
E	0.60		0.80	0.024		0.031
F	-	1.1	-	-	0.043	-
G	-	1.27	-	-	0.050	-
H	-	2.30	-	-	0.091	-
J	0.36		0.50	0.014		0.020
K	12.70		15.0	0.500		0.591
N	2.04		2.66	0.080		0.105
P	1.86		2.06	0.073		0.081
V	-		4.3	-		0.169

**SOT-223 Package Mechanical Data**

Ref.	Dimensions					
	Millimeters			Inches		
	Min.	Typ.	Max.	Min.	Typ.	Max.
A	1.5	1.6	1.8	0.059	0.063	0.071
A1	0	0.06	0.10	0	0.002	0.004
B	2.9	3.0	3.1	0.114	0.118	0.122
B1	0.6	0.7	0.8	0.024	0.028	0.031
C	0.22	0.26	0.32	0.009	0.010	0.013
D	6.3	6.5	6.7	0.248	0.256	0.264
E	3.3	3.5	3.7	0.130	0.138	0.146
F		4.6			0.181	
F1		2.3			0.091	
G	0.7	0.9	1.1	0.028	0.035	0.043
H	1.5	1.75	2.0	0.059	0.069	0.079
J	6.7	7.0	7.3	0.264	0.276	0.287
K	0.8	0.9	1.0	0.031	0.035	0.039